

breezesta™

SKYLINE GARDEN BENCH 36"

SK-0405-36

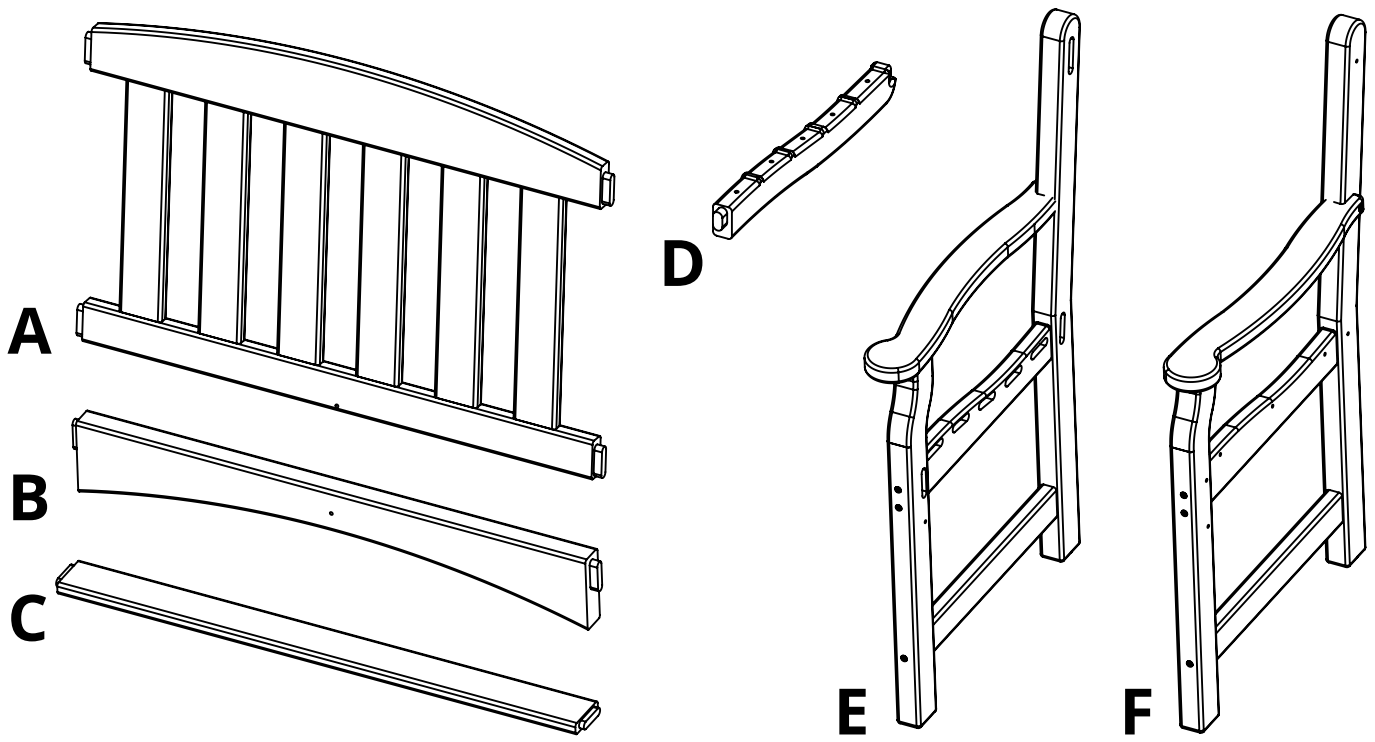



PARTS

PART	DESCRIPTION	PART NO.	QTY
A	BACK ASSEMBLY	SA-00170	1
B	FRONT RAIL 36"	PRT-00318	1
C	36IN SEAT SLAT	SS-33.562	5
D	SEAT SUPPORT	PRT-00294	1
E	LEFT SIDE ASSEMBLY	SA-00159	1
F	RIGHT SIDE ASSEMBLY	SA-00160	1

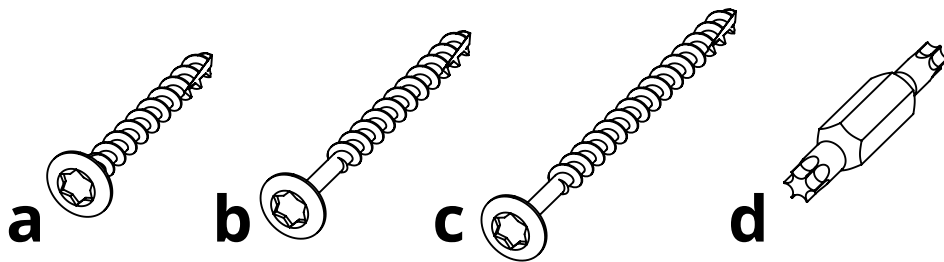

HARDWARE

PART	DESCRIPTION	PART NO.	QTY
a	#8 X 1-1/2" TORX SCREW	H-0000-S815	7
b	#8 X 2" TORX SCREW	H-0000-S82	5
c	#8 X 2-1/2" TORX SCREW	H-0000-S825	9
d	DOUBLE SCREW	H-0000-DS	1

Suggested Tools: Drill, Plastic Mallet

Please read entire instructions before beginning

1. Attach Parts E & F to Parts A & B using Hardware c

Cx8

T20

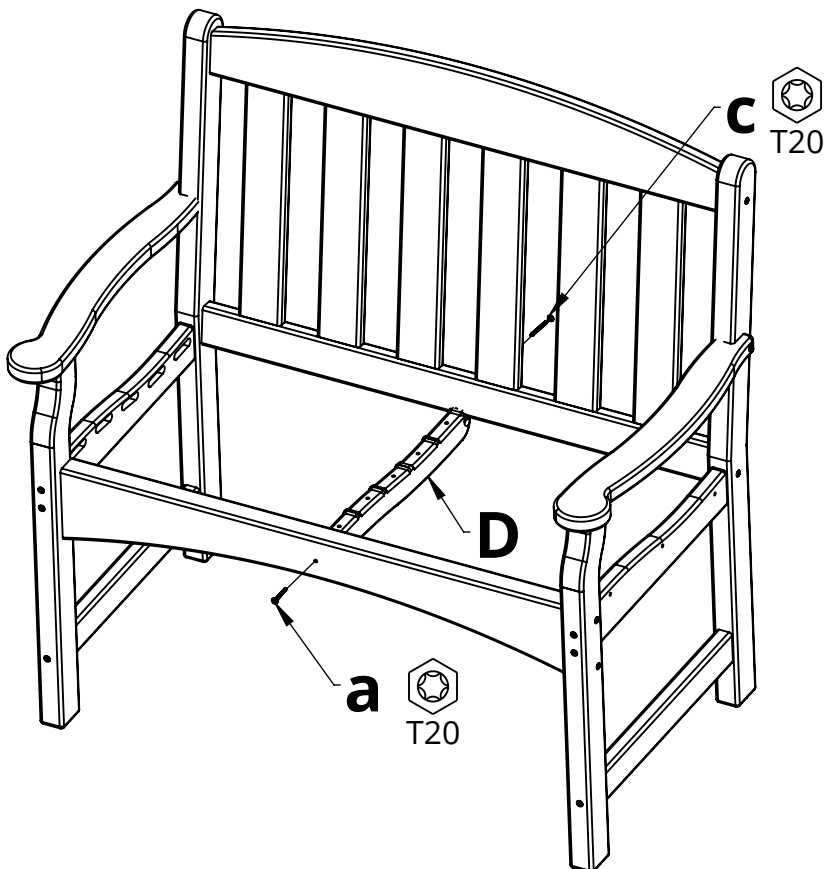
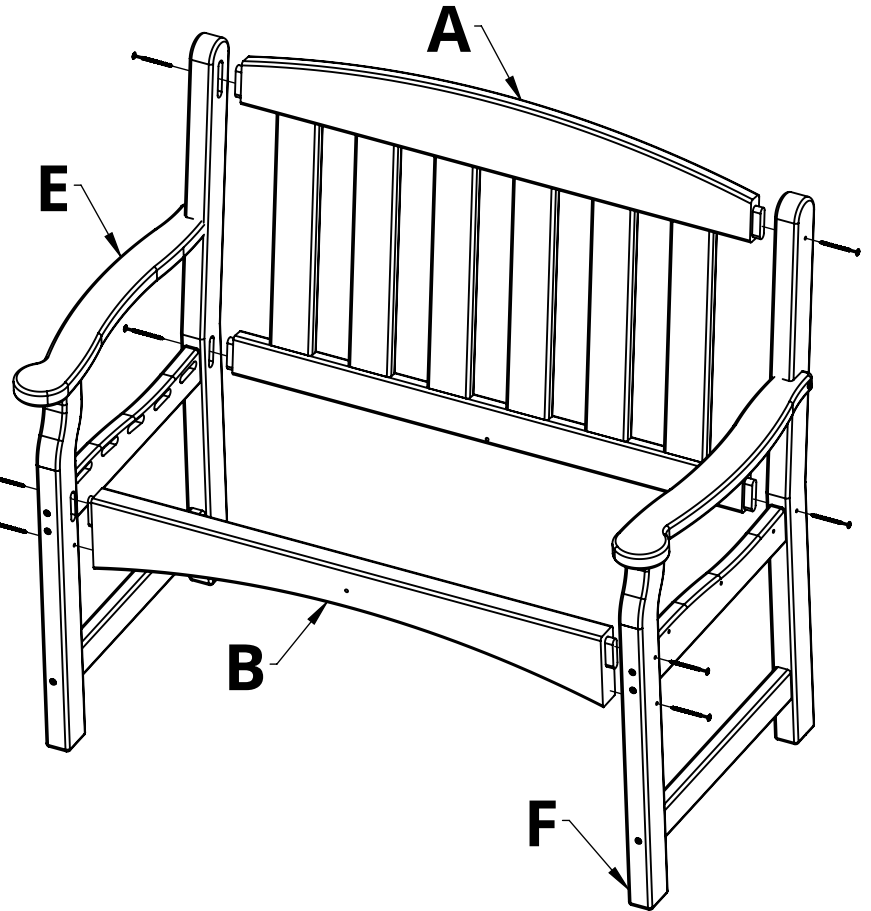

2. Connect Part D to the previous assembly as shown

Mortise

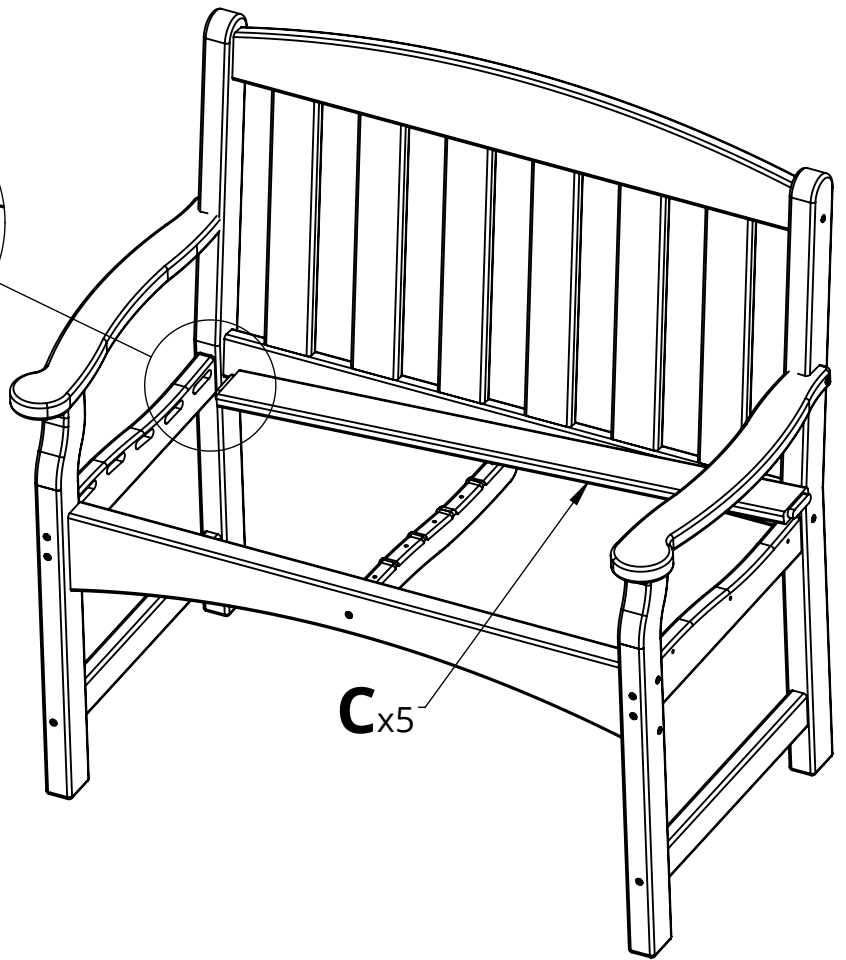
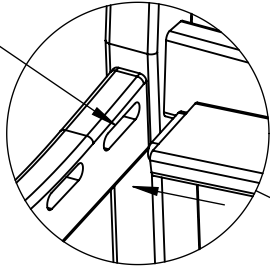

3. Slide one end of Parts C into the mortise as shown & flex it into the mortise on the other end

Cx5

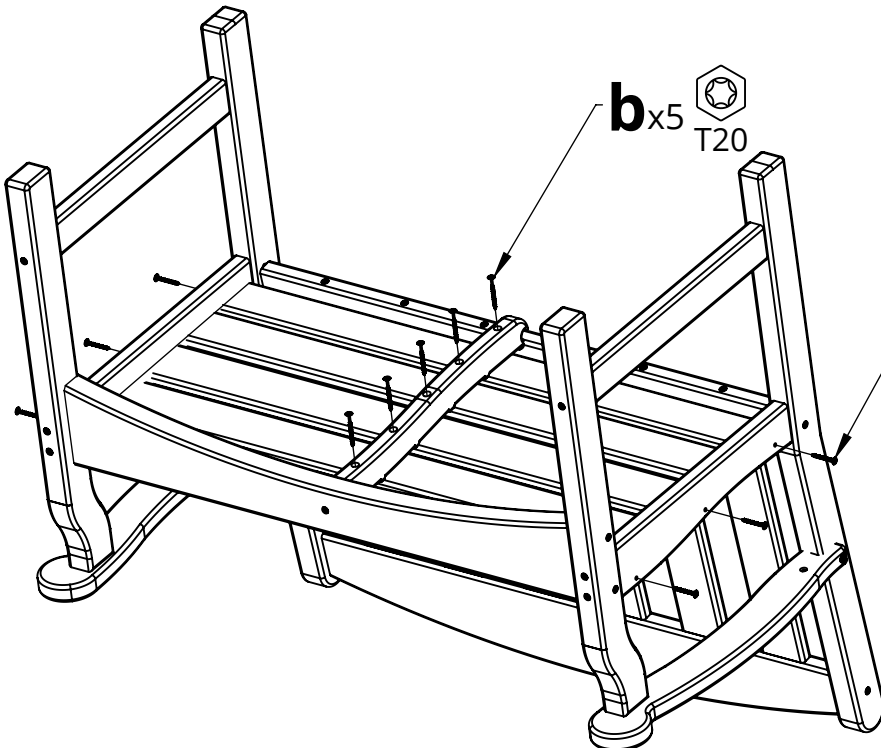

bx5
T20

ax6
T20

4. Secure the assembly using Hardware a & b as shown